

# Ecophon Solo™ Rectangle

Solo Rectangle är en frihängande enhet som erbjuder stora designmöjligheter. Tre olika upphängningssystem gör det möjligt att skapa flera olika lager och vinklar. Detta är en fördel när man vill upprätthålla rummets storlek eller när det inte går att installera ett vägg-till-vägg-tak.



M30 Architects, Oisterwijk, Netherlands

## SYSTEMÖVERSIKT

Format c, mm	1800x1200	2400x600	2400x1200	3000x1200
Special	•	•	•	•
Tjocklek (tj)	40	40	40	40
Principskiss	M404, M506	M405	M406, M407, M506	M408

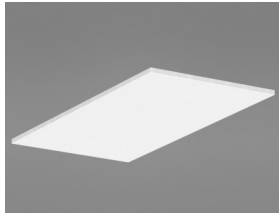

Solo Rectangle

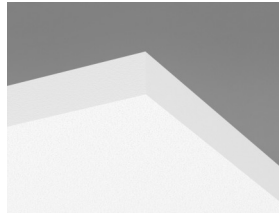

Solo absorbent

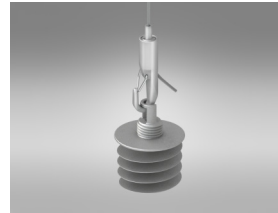

Montage med Connect Justerbar Wireupphängning och Absorbentankare



Montage med Connect Solo Justerbart Direktfäste och Connect Solo Absorbentankare



## Akustik

Värdena i diagrammet avser en absorbent. Om absorbenterna monteras i grupp med mindre inbördes avstånd än 0,5 meter, kommer absorptionsmängden per styck att bli lägre.

### Ljudabsorption:

Provningsresultat enligt EN ISO 354.

$A_{eq}$  Absorptionsmängd per st ( $m^2$  sabin)

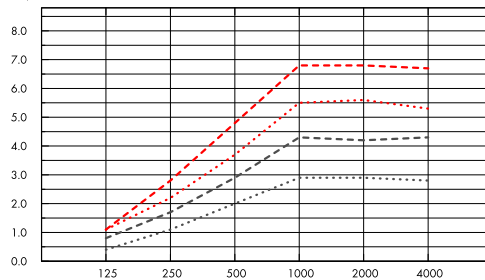

- ..... Solo Rectangle 2400x1200, 1000 mm o.d.s.
- Solo Rectangle 1800x1200, 1000 mm o.d.s.
- ..... Solo Rectangle 2400x600, 1000 mm o.d.s.
- . - . - Solo Rectangle 3000x1200, 1000 mm o.d.s.

Frekvens Hz

	tj mm	ikh mm	$A_{eq}$ Absorptionsmängd per st ( $m^2$ sabin)					
			125 Hz	250 Hz	500 Hz	1000 Hz	2000 Hz	4000 Hz
2400x1200	40	200	1.3	2.8	3.5	4.1	4.1	3.9
2400x1200	40	400	1.2	2.4	3.3	4.7	4.9	4.7
2400x1200	40	1000	1.1	2.2	3.7	5.5	5.6	5.3
1800x1200	40	200	0.6	2.0	2.9	3.4	3.3	3.1
1800x1200	40	400	0.8	1.9	2.6	3.7	3.7	3.6
1800x1200	40	1000	0.8	1.7	2.9	4.3	4.2	4.3
2400x600	40	200	0.5	1.4	2.0	2.4	2.3	2.3
2400x600	40	400	0.4	1.2	1.8	2.6	2.7	2.7
2400x600	40	1000	0.4	1.1	2.0	2.9	2.9	2.8
3000x1200	40	200	1.1	3.3	4.4	5.1	5.1	5.0
3000x1200	40	400	1.2	3.0	4.2	5.8	5.8	5.7
3000x1200	40	1000	1.1	2.8	4.8	6.8	6.8	6.7



## Inomhusmiljö

Miljömärkning	Standard	Plant
Eurofins Indoor Air Comfort®	IAC	IAC Gold
Fransk VOC	A	A+
Finsk M1	•	•





## Environmental Footprint

	Kg CO <sub>2</sub> equiv/m <sup>2</sup>
Solo Rectangle	9,12 (Solo Family EPD i enlighet med ISO 14025 / EN 15804)
Solo Rectangle/Plant	5,32 (Solo Rectangle/Plant EPD i enlighet med ISO 14025 / EN 15804)



## Circularity

Minsta andel återvunnet material efter konsumentledet	57%
Återvinningsbarhet	Helt återvinningsbar



## Brandsäkerhet

Land	Standard	Klass
Europa	EN 13501-1	A2-s1,d0

Ljudabsorbenternas kärna är testad och klassificerad som ej brännbar enligt EN ISO 1182.



## Fuktbeständighet

Produkt	Klass
Standard	Class C, RH 95% and 30°C
Plant	Class A, RH 70% and 25°C

Enligt EN 13964: 2014



## Ljuseffektivitet

White Frost, närmaste NCS-färgprov S 0500-N, 85 % ljusreflektion. Glans <1.



## Rengörbarhet

Systemet tål daglig dammtorkning och dammsugning samt våttvorkning en gång per vecka.



## Tillgänglighet

Absorbenterna är demonterbara.



## Montering

Monteras enligt Principskisser, Installationsguider och Drawing Aid. För information om minsta totala konstruktionshöjd se Materialspecifikation



## Systemvikt

Ungefärlig vikt på cirka 6,5-17,5 kg.



## Mekaniska egenskaper

Absorbenten kan bära punktlaster och utbredda laster. Se Funktionskrav, Mekaniska egenskaper på [www.ecophon.se](http://www.ecophon.se).

**CE**

---

Ecophons undertakssystem är CE-märkta enligt den europeiska harmoniserade standarden EN13964: 2014. CE-märkta byggprodukter omfattas av en prestandadeklaration (DOP) som gör det möjligt för kunder och användare att enkelt jämföra prestanda för produkter som är tillgängliga på den europeiska marknaden.

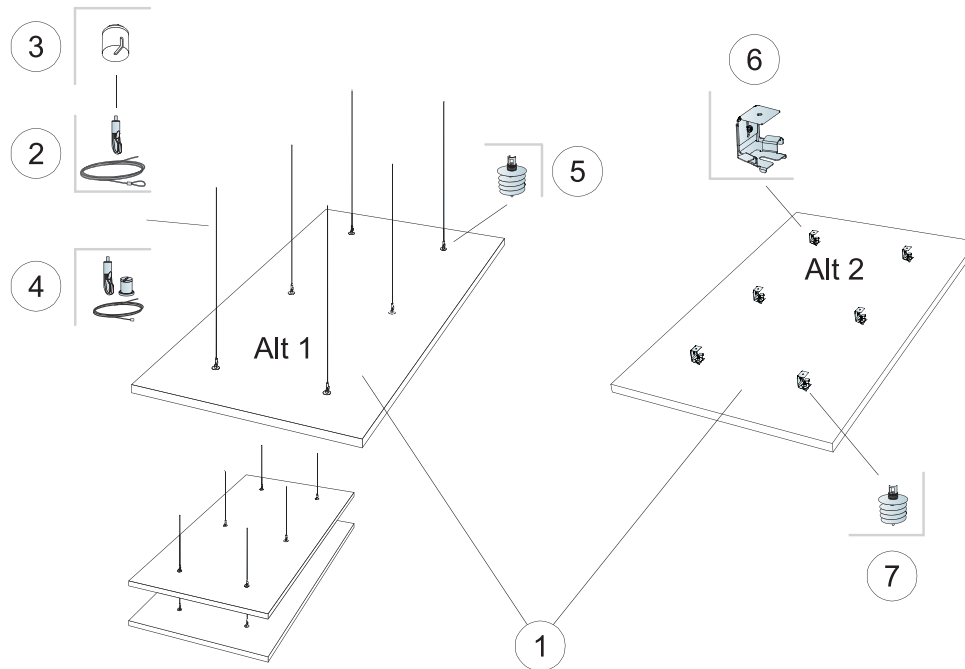

MATERIALSPECIFIKATION (EXKL. SPILL)

		Storlek, mm
		1800x1200
1	Solo Rectangle	2,16m <sup>2</sup> /panel
2	Connect Justerbar Wireupphängning (Alt 1)	6/absorbent
3	Connect Solo Takkopp (Alt 1, valfritt)	6/absorbent
4	Connect Wireupphängning (Alt 1, valfritt)	6/absorbent
5	Connect Absorbentankare (Alt 1)	6/absorbent
6	Connect Solo Justerbart Direktfäste (Alt 2)	6/absorbent
7	Connect Absorbentankare (Alt 2)	6/absorbent
Δ Min. total konstruktionshöjd: Δ1 140 mm / Δ2 90 mm		-

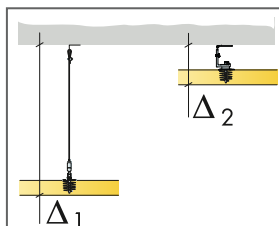

Se Materialspecifikation

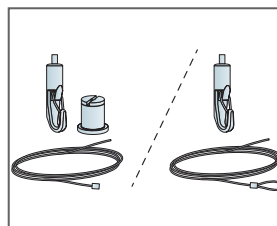

Två typer av lösningar med Wireupphängning

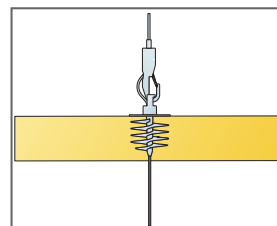

Absorbenterna kan hängas under varandra

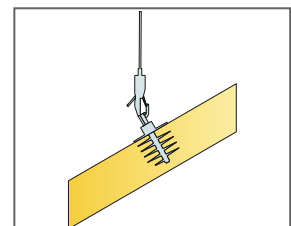

Absorbenterna kan monteras i vinklar

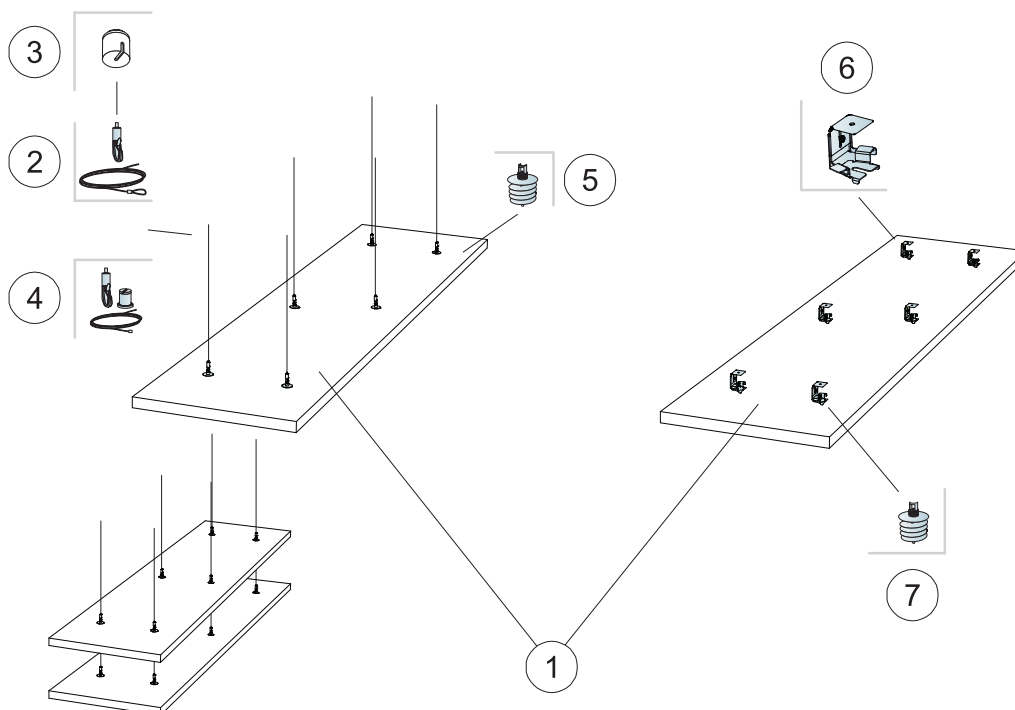

MATERIALSPECIFIKATION (EXKL. SPILL)

		Storlek, mm
		2400x600
1	Solo Rectangle	1,44m <sup>2</sup> /panel
2	Connect Justerbar Wireupphängning (Alt 1)	6/absorbent
3	Connect Solo Takkopp (Alt 1, valfritt)	6/absorbent
4	Connect Wireupphängning (Alt 1, valfritt)	6/absorbent
5	Connect Absorbentankare (Alt 1)	6/absorbent
6	Connect Solo Justerbart Direktfäste (Alt 2)	6/absorbent
7	Connect Absorbentankare (Alt 2)	6/absorbent
Δ Min. total konstruktionshöjd: Δ1 140 mm / Δ2 90 mm		-

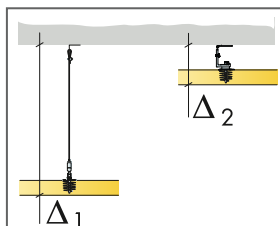

Se Materialspecifikation

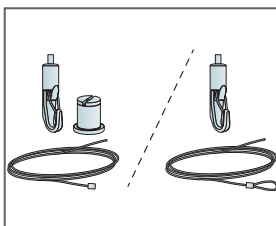

Två typer av lösningar med Wireupphängning

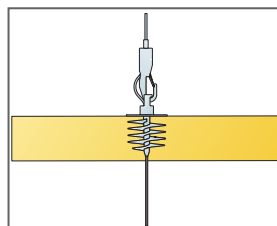

Absorbenterna kan hängas under varandra

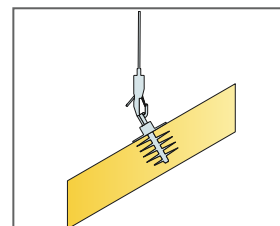

Absorbenterna kan monteras i vinklar

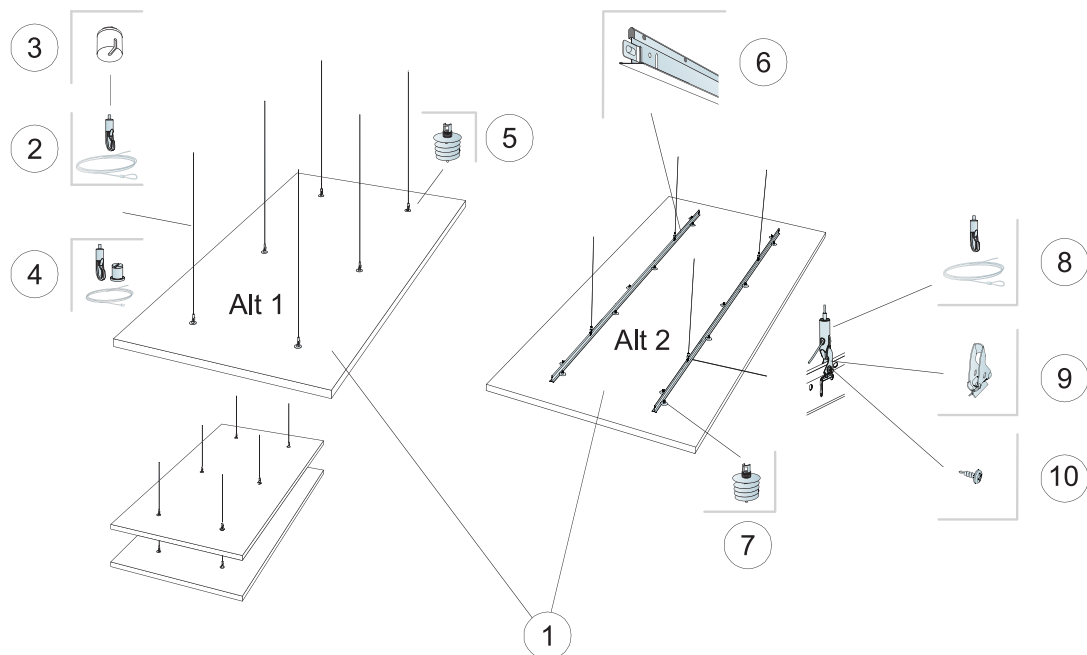

### MATERIALSPECIFIKATION (EXKL. SPILL)

		Storlek, mm
		<b>2400x1200</b>
1	Solo Rectangle	2,88m <sup>2</sup> /panel
2	Connect Justerbar Wireupphängning (Alt 1)	6/absorbent
3	Connect Solo Takkopp (Alt 1, valfritt)	6/absorbent
4	Connect Wireupphängning (Alt 1, valfritt)	6/absorbent
5	Connect Absorbentankare (Alt 1)	6/absorbent
6	Connect T24 Huvudprofil (Alt 2)	2/absorbent
7	Connect Absorbentankare (Alt 2)	14/absorbent
8	Connect Justerbar Wireupphängning (Alt 2)	4/absorbent
9	Connect Pendelfäste (Alt 2)	4/absorbent
10	Connect Montageskruv BR (Alt 2)	4/absorbent
Δ Min. total konstruktionshöjd: Δ1 140 mm / Δ2 200 mm		-

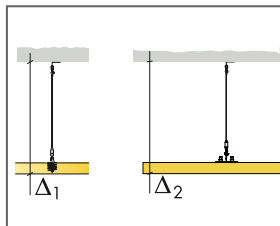

Se Materialspecifikation

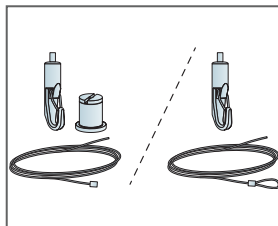

Två typer av lösningar med Wireupphängning

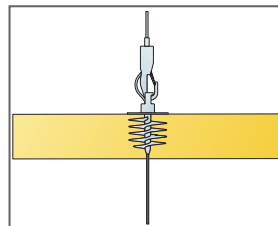

Absorbenterna kan hängas under varandra

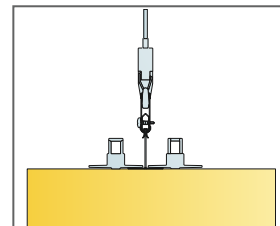

Montage med T24 Huvudprofil

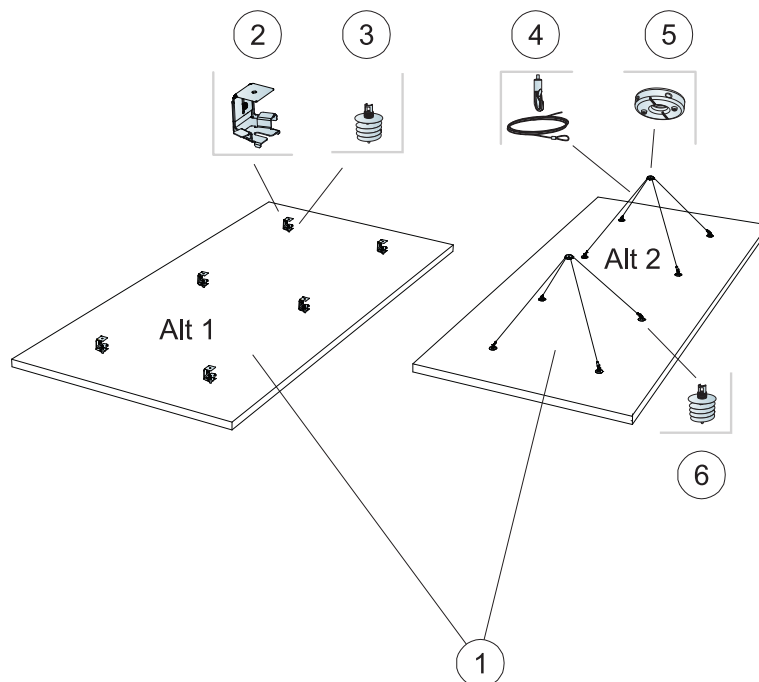

MATERIALSPECIFIKATION (EXKL. SPILL)

		Storlek, mm
		<b>2400x1200</b>
1	Solo Rectangle	2,88m <sup>2</sup> /panel
2	Connect Solo Justerbar Direktfäste (Alt 1)	6/absorbent
3	Connect Solo Absorbentankare (Alt 1)	6/absorbent
4	Connect Justerbar Wireupphängning (Alt 2)	4/absorbent
5	Connect Wire Enpunktsfäste (Alt 2)	2/absorbent
6	Connect Absorbentankare (Alt 2)	8/absorbent
Δ Min. total konstruktionshöjd: Δ1 90 mm / Δ2 500 mm		-

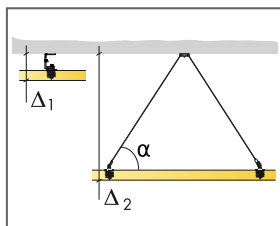

Se Materialspecifikation

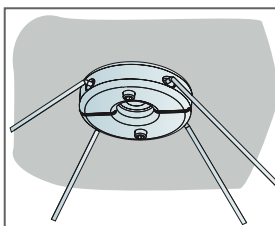

Detalj på Wire Enpunktsfäste

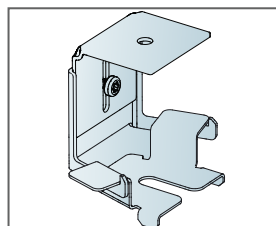

Justerbar direktfäste. Total konstruktionshöjd 90-130mm



## PRINCIPSKISS (M408) FÖR ECOPHON SOLO RECTANGLE 3000X1200

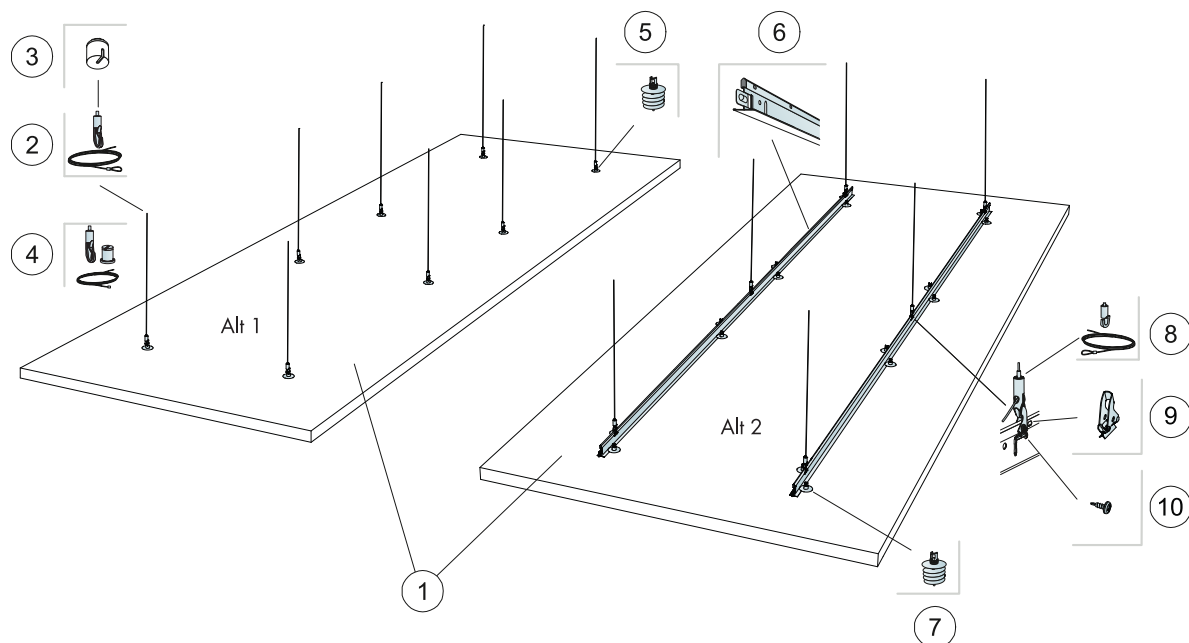

### MATERIALSPECIFIKATION (EXKL. SPILL)

		Storlek, mm
		3000x1200
1	Solo Rectangle	3,6m <sup>2</sup> /panel
2	Connect Justerbar Wireupphängning (Alt 1)	8/absorbent
3	Connect Solo Takkopp (Alt 1, Rekommenderad)	8/absorbent
4	Connect Justerbar Wireupphängning kit (Alt 1, Rekommenderad)	8/absorbent
5	Connect Absorbentankare (Alt 1)	8/absorbent
6	Connect T24 Huvudprofil (Alt 2)	2/absorbent
7	Connect Absorbentankare (Alt 2)	16/absorbent
8	Connect Justerbar Wireupphängning (Alt 2)	6/absorbent
9	Connect Pendelläste (Alt 2)	6/absorbent
10	Connect Montageskruv BR (Alt 2)	6/absorbent
Δ Min. total konstruktionshöjd: Δ1 140 mm / Δ2 200 mm		-

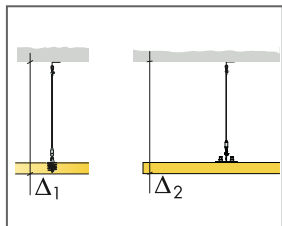

Se Materialspecifikation

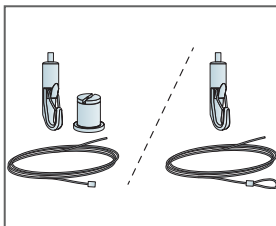

Två typer av lösningar med Wireupphängning

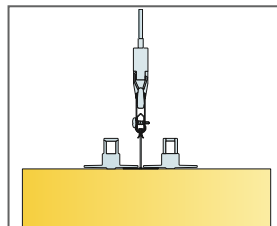

Montage med T24 Huvudprofil

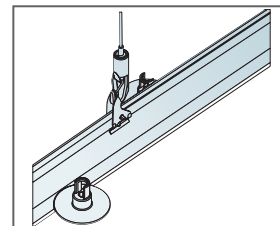

Installation med pendelläste

## PRINCIPSKISS (M506) FÖR ECOPHON SOLO RECTANGLE

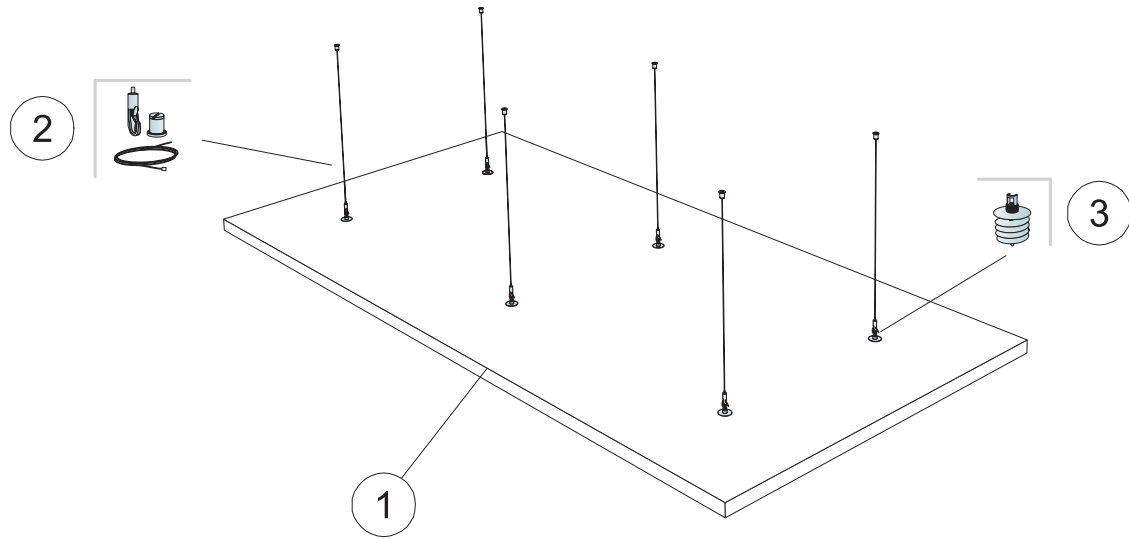

### MATERIALSPECIFIKATION (EXKL. SPILL)

	Storlek, mm	
	1800x1200	2400x1200
1 Solo Rectangle	2,16m <sup>2</sup> /panel	2,88m <sup>2</sup> /panel
2 Connect Justerbar Wireupphängning (ingår)	-	-
3 Connect Absorbentankare (ingår)	-	-
Δ Min. total konstruktionshöjd: Δ 140 mm	-	-
För att montera Connect Solo Absorbentankare, använd Connect Solo Absorbentankarbit.	-	-

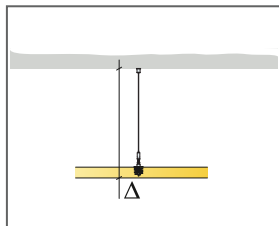

Se Materialspecifikation

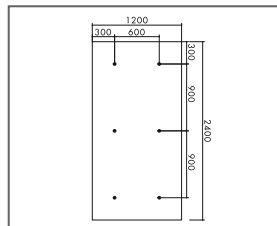

Placering av Connect Absorbentankare, format 2400x1200

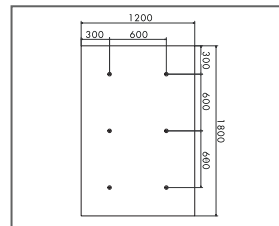

Placering av Connect Absorbentankare, format 1800x1200

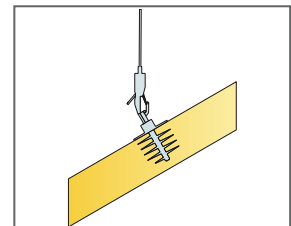

Absorbenterna kan monteras i vinklar