

Different facings possible

Plate insulation = 40 mm or 2x 20 mm	Stiffener insulation = 20 mm
U SeaProtect Slab 76 Alu1	U SeaProtect Slab 76 Alu1
U SeaProtect Slab 76 G120	U SeaProtect Slab 76 G120
U SeaProtect Slab 76 G220	U SeaProtect Slab 76 G220
U SeaProtect Slab 76 G420	U SeaProtect Slab 76 G420
U SeaProtect Slab 76 B-Al	U SeaProtect Slab 76 B-Al
U SeaProtect Slab 76 B-Gl	U SeaProtect Slab 76 B-Gl



A30 Steel Bulkhead - General Application
 ULTIMATE - U SeaProtect - Thin design
 Plate: 76 - 40 mm or 76-2x20 mm / Stiffener: 76 - 20 mm
 Reference: MED-B-9333

Drawing number: AK2323
 Page: 1
 Version: Rev 1
 Date: 01.09.2015

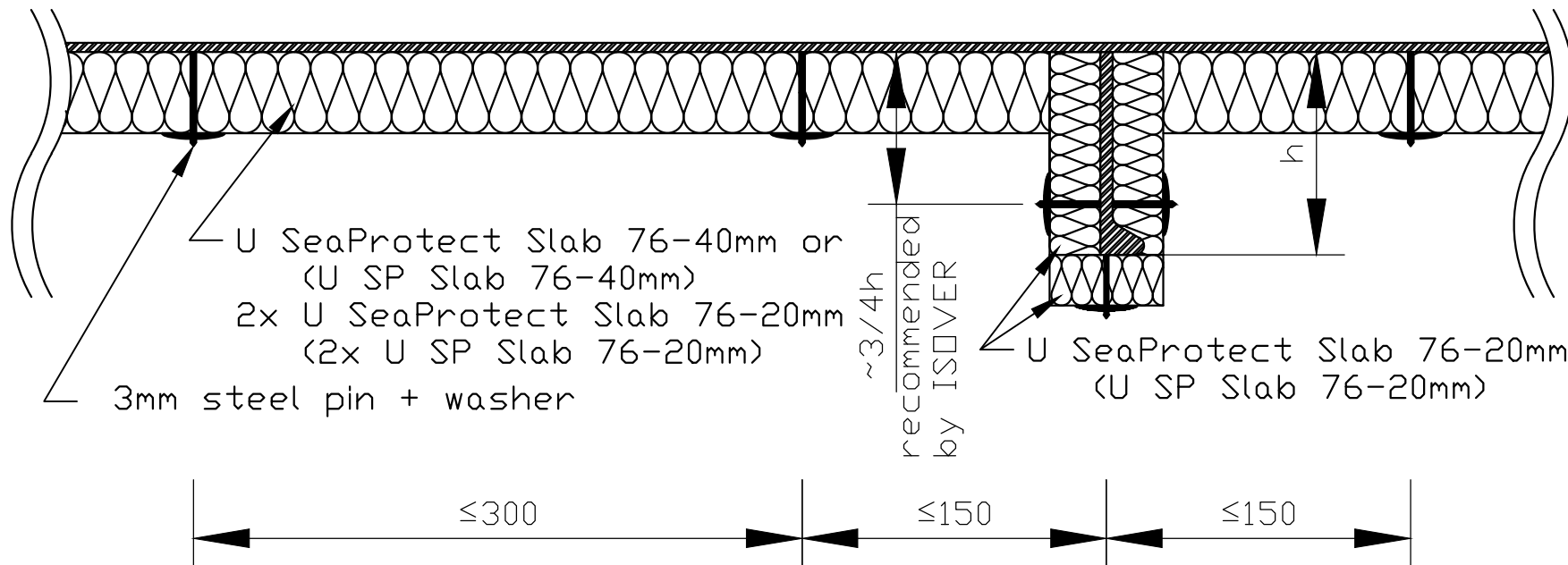

Different facings possible

Plate insulation = 40 mm or 2x 20 mm	Stiffener insulation = 20 mm
U SeaProtect Slab 76 Alu1	U SeaProtect Slab 76 Alu1
U SeaProtect Slab 76 G120	U SeaProtect Slab 76 G120
U SeaProtect Slab 76 G220	U SeaProtect Slab 76 G220
U SeaProtect Slab 76 G420	U SeaProtect Slab 76 G420
U SeaProtect Slab 76 B-Al	U SeaProtect Slab 76 B-Al
U SeaProtect Slab 76 B-Gl	U SeaProtect Slab 76 B-Gl



A30 Steel Bulkhead - General Application
 ULTIMATE - U SeaProtect - Thin design
 Plate: 76 - 40 mm or 76-2x20 mm / Stiffener: 76 - 20 mm
 Reference: MED-B-9333

Drawing number: AK2323
 Page: 2
 Version: Rev 1
 Date: 01.09.2015

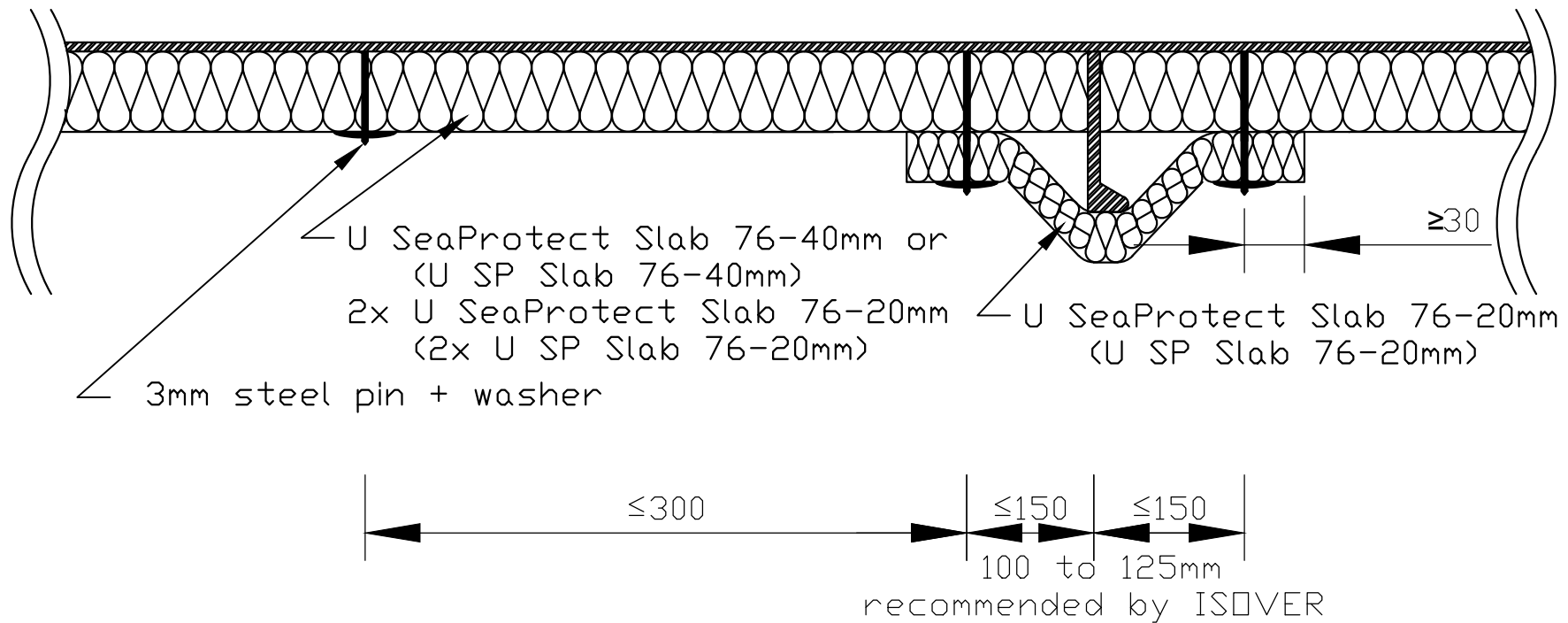

Different facings possible

Plate insulation = 40 mm or 2x 20 mm	Stiffener insulation = 20 mm
U SeaProtect Slab 76 Alu1	U SeaProtect Slab 76 Alu1
U SeaProtect Slab 76 G120	U SeaProtect Slab 76 G120
U SeaProtect Slab 76 G220	U SeaProtect Slab 76 G220
U SeaProtect Slab 76 G420	U SeaProtect Slab 76 G420
U SeaProtect Slab 76 B-Al	U SeaProtect Slab 76 B-Al
U SeaProtect Slab 76 B-Gl	U SeaProtect Slab 76 B-Gl



A30 Steel Bulkhead - General Application
 ULTIMATE - U SeaProtect - Thin design
 Plate: 76 - 40 mm or 76-2x20 mm / Stiffener: 76 - 20 mm
 Reference: MED-B-9333

Drawing number: AK2323
 Page: 3
 Version: Rev 1
 Date: 01.09.2015

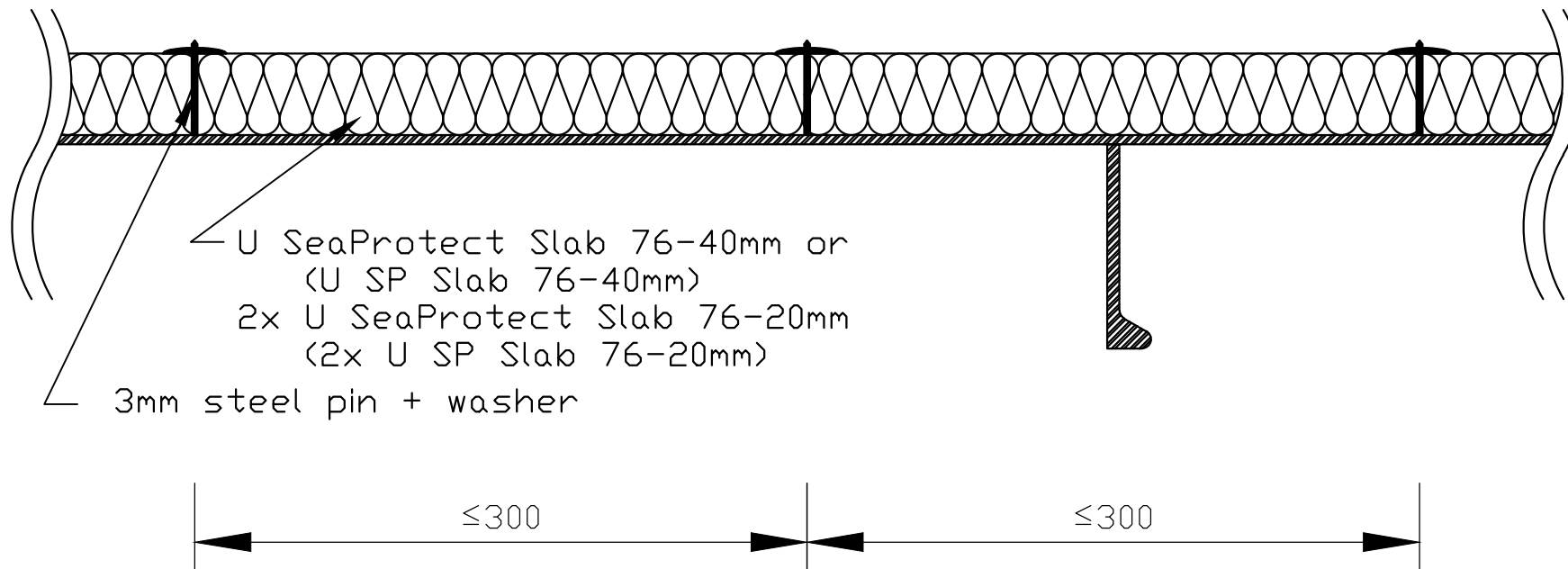

Different facings possible

Plate insulation = 40 mm or 2x 20 mm	No Stiffener insulation
U SeaProtect Slab 76 Alu1	
U SeaProtect Slab 76 G120	
U SeaProtect Slab 76 G220	
U SeaProtect Slab 76 G420	
U SeaProtect Slab 76 B-Al	
U SeaProtect Slab 76 B-Gl	



A30 Steel Bulkhead - General Application
 ULTIMATE - U SeaProtect - Thin design
 Plate: 76 - 40 mm or 76-2x20 mm / Stiffener: 76 - 20 mm
 Reference: MED-B-9333

Drawing number: AK2323
 Page: 4
 Version: Rev 1
 Date: 01.09.2015